

Contents

Help?

If this instruction manual does not give an answer or if 'Tips' does not solve your TV problem, you can call your Local Philips Customer or Service Centre. See the supplied World-wide guarantee booklet.

Please, have the Model and Product number which you can find at the back of your television set or on the packaging ready, before calling the Philips helpline.

Model: 42PF9830/93

Product No:

Care of the screen

See p. 3.



End of life directives

Philips is paying a lot of attention to producing environmentally-friendly in green focal areas. Your new TV contains materials which can be recycled and reused. At the end of its life specialised companies can dismantle the discarded TV to concentrate the reusable materials and to minimise the amount of materials to be disposed of. Please ensure you dispose of your old TV according to local regulations.

Preparation	2
First time installation	2
To operate the motorised swivel	3
Keys at the top of the TV	3
Use of the remote control RC4310	4
Browse screen	6
To use the menus	7
Introduction	7
How to navigate through the Settings menus	7
Demo	7
Installation	
Select the menu language	8
Store TV channels	8
Software upgrade	10
Setup menu	
Preferences	11
Source	13
TV menu	
Picture menu	14
Sound menu	16
Features menu	17
Ambilight menu	18
Multimedia Browser	
Viewing content from a Memory card / USB device	19
Multimedia Browser menu	20
Teletext	21
Teletext menu	22
Connect to connect to the side connections	22
Connect Peripheral Equipment	23
Recorder (vcr-dvd+rw)	24
Recorder and other A/V equipment	25
DVD Player or other accessory digital source equipment	26
MultiChannel Surround receiver	27
Devices to connect to a HDMI connector	28
Devices to connect to a DVI connector	29
Record with your recorder	30
To select connected peripherals	30
Audio- and video equipment keys	31
Setting the remote control to work peripheral equipment	
Code setup	32
To cancel the selected mode	32
Learnable remote control	34
Tips	36
Annex 1 - Philips TV software upgrade with portable memory ..	37
Annex 2 - Philips TV Slideshow Format with background music.	39
Annex 3 - Philips TV - Portable Memory and USB	41



Preparation

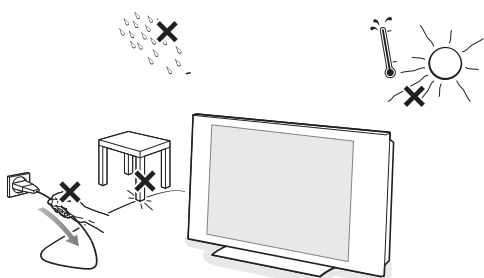

Do not insert the power plug in a wall socket or hang the TV to the wall before all connections are made.

1 Wall mounting instructions/Table stand/Motorised swivel

How to mount the supplied stand and/or wall mount bracket and the swivel, see the supplied separate Quick Start Guide.

Caution: Installing the TV requires special skills that should only be performed by qualified personnel. You should not attempt to do the work yourself. Philips bears no responsibility for improper mounting or mounting that results in accident or injury.

Using the supplied bracket to mount the TV:

- You can ask a qualified service personnel about using the bracket to mount the display on the wall.
- Follow the instructions that come with the bracket before beginning work.
- Make sure that the wall mount is being fixed securely enough so that it meets safety standards. The weight of the TV (excl. packaging) is about 42 kg.

2 Place or hang the TV wherever you want, but make sure that air can circulate freely through the ventilation slots. Do not install the TV in a confined space such as a book case or a similar unit.

To prevent any unsafe situations, no naked flame sources, such as lighted candles, should be placed in the vicinity. Avoid heat, direct sunlight and exposure to rain or water.

The equipment shall not be exposed to dripping or splashing.

3 Insert the aerial plug firmly into the aerial socket at the bottom of the TV. For best picture quality use the suppressor-aerial cable supplied.

4 Before installing your TV, connect all your peripheral equipment. See p. 23.

5 Insert the mains cord supplied into the mains at the bottom of the TV and in the wall socket having a mains voltage of 160-276V.

To prevent damaging the power (AC) cord which could cause a fire or electric shock, do not place the TV on the cord.

6 Remote control: Insert the 2 batteries supplied (Type R6-1,5V).

The batteries supplied do not contain the heavy metals mercury and cadmium.

Please check on how to dispose of exhausted batteries according to local regulations.

7 Switch the TV on : Press the power switch at the top of the TV.

An indicator on the front of the TV lights up and the screen comes on. If the TV is in standby mode, press the **-P+** keys or the  key on the remote control.

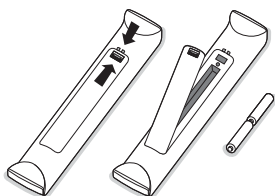
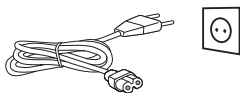

First time installation

The **first time** (and only the first time) you switch on your set, you see an installation introduction screen. The **installation procedure** consists of a series of screens that guide you through the process.

- 1 After an introduction screen, you are asked to select a language of the TV's on-screen-menus. (The text of the header and the info on screen continuously change language.)
- 2 Press the cursor up/down to highlight your language.
- 3 Press the ok key.
- 4 Follow the instructions on screen to proceed.

Note: Once you completed the initial installation procedure, you may access the screens from the Settings menu. See p.11..

To operate the motorised swivel



The motorised swivel can turn + and - 30 degrees and can be operated with the remote control of your TV. Manual rotation remains possible too.

Preparation

- 1 Insert the DC cable of the swivel transformer into the **DC** input of the swivel.
- 2 Insert the power cord to the swivel transformer.
- 3 Insert the mains plug of the swivel transformer in the wall socket.

Operation

First press the **SWIVEL MOT** key at the side of your remote control and keep it pressed.

Then simultaneously:

- press the cursor left/right to rotate the swivel in the direction of the command;
- press the the cursor down to bring the swivel in a central position;
- press the cursor up to return the swivel to the last selected position.

Note: After a power drop or a power cord plug out, adjust the swivel position with the cursor left/right.

Automatic positioning to central position

Press the  key for at least 5 seconds to switch off your TV and to turn the swivel to its central position.

Keys at the top of the TV

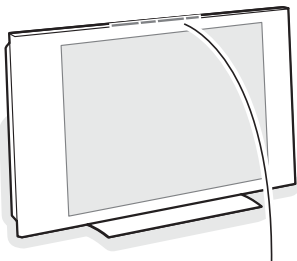

Should your remote be lost or broken you can still change some of the basic settings with the keys on the top of your TV.

Press the power switch  to switch the TV on.

Press:

- the  - or + keys to adjust the volume;
- the **P/CH** - or + keys to select the TV channels or sources.

The **MENU** key can be used to summon the Settings menu without the remote control.

Use:

- the  - and + keys and the **P/CH**  and **P/CH**  keys to select menu items;
- the **MENU** key to confirm your selection.

Note:

*When activated via the **MENU** key on top of the TV, only **Exit** lets you dismiss the menu.*

*Navigate to **Exit**, press the cursor right and then press the **MENU** key.*

Care of the screen

Do not touch, push or rub or strike the screen with anything hard as this may scratch, mar or damage the screen permanently. And please do not rub with dust clothes with chemical treatment.

Do not touch the surface with bare hands or greasy cloth (some cosmetics are detrimental to the screen).

Unplug the TV before cleaning the screen.

When the surface becomes dusty, please wipe gently with absorbent cotton or other soft materials like chamois soaks.

Do not use acetone, toluene and alcohol because they cause chemical damage.

Do not use liquid cleaners or aerosol cleaners.

Wipe off saliva or water drops as soon as possible. Their long time contact with the screen causes deformations and colour fading.

Use of the remote control RC4310

Note: For most keys pressing a key once will activate the function. Pressing a second time will de-activate it. When a key enables multiple options, a small list will be shown. Press repeatedly to select the next item in the list. The list will be removed automatically after 6 seconds or press **OK** to remove immediately.

DVD/R SAT TV VCR AUX

Press the **SELECT** key repeatedly to select one of the system modes in which the remote control can be used. If no action is being undertaken within 60 seconds, the remote control returns to TV mode. After an action in the selected system mode the remote control will remain in this mode for 60 seconds and will then return to TV mode.

Select connected equipment

Press and hold this key until the source indication appears, then press repeatedly to select **AV1**, **AV2**, **AV3**, **DVI**, **HDMI**, **Side** or **TV**, according to where you connected your peripheral equipment.

BROWSE On/Off

Press to display the Browse menu On or Off. See p. 6.

- OK**
- to activate a setting
 - to display the channel list
 - starts playing content in the Multimedia Browser application, p. 20.

(MOT) SWIVEL key

To control the motorised swivel in combination with the cursor keys. See p. 3.

MENU Settings menu on/off

See p. 11.

Volume

Press + or - to adjust the volume.

Interrupt the sound or restore it.

Alphanumeric keys

To select a TV channel. See p. 6.

Display information

Press to display (when available) information about the selected TV channel and programme.



- Audio and Video equipment keys. See p. 31.
- Multimedia browser functional keys. See p. 20.

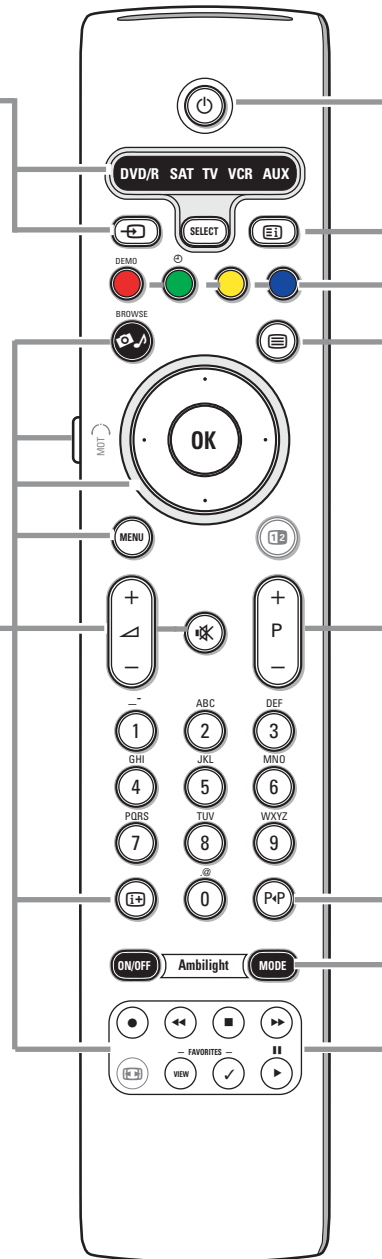

Standby

Press to switch the TV on or off from or to standby mode.

When switched to standby, a red indicator on the TV lights up.

Note: the TV is never powered off completely unless it is physically unplugged.

DEMO Demo on/off

See p. 7

Colour keys

When functions are attached to the colour keys, the colour keys show on screen.

Teletext index page

See p. 21.

Teletext On/Off

See p. 21.

Cursor keys

Press the cursor keys up/down, left/right to navigate through the menus.

+P- Channel selection

To browse through the TV channels and sources stored in the preferred channels list.

P+P Previous programme

Press to alternate between the currently viewed and the previously viewed TV channel.

AMBILIGHT

ON/OFF

Press to switch Ambilight On or Off. For the Ambilight settings, see TV menus, Ambilight, p. 18.

MODE

Press this key repeatedly to toggle through the Ambilight modes.

FAVORITES

- **VIEW** To display a list of all channels marked as favourite.
- **✓** To add or remove a channel in the favourite list of TV channels.



12 Dual screen/PIP

Press the **12** key to switch on or off Dual screen or PIP, according to the format selection made in the **PIP format** list in the Setup, Picture/sound preferences menu, p. 11.

PIP allows you to call up a subscreen within the main screen enabling you to watch two TV channels or a TV channel and pictures from a peripheral at the same time.

Dual screen allows you to divide the main screen into two subscreens enabling two TV channels or a TV channel and an external source or a combination of one of them with Teletext (see p. 21) to be watched simultaneously.

Note: Not all combinations might be possible. In such a case a message appears on the screen.

- 1 Press the cursor left/right to highlight the PIP window or the left/right screen in Dual screen
- 2 Press the **-P+** key or the **-P-** key or the digit keys in order to change TV channels, external sources or teletext pages in the highlighted screen.
- 3 Press the **12** key again to return to a full main screen picture. The TV tunes to the picture which was highlighted in the Dual screen or PIP mode.

Notes:

- Audio only plays from the main, when PIP has been selected, or from the left screen, when Dual screen has been selected.
- When in Dual screen, two display formats are supported: full screen or squeezed.
- Multimedia browser content will always be displayed full screen.
- When PIP or Dual screen mode is activated, and a TV channel or source is locked, the picture is grayed out.

Define the position of the PIP screen

- 1 Press the cursor right to highlight the PIP screen.
- 2 Press the red colour key on the remote control to select **Position**.
Note: If no action has been undertaken, the function bar at the bottom of the screen will disappear after a few seconds. Press any colour key to make it re-appear.
- 3 Use the cursor keys to define the position of the PIP screen.

Picture format

Press this key repeatedly to select another picture format: Auto format, Super zoom, 4:3, Movie Expand 14:9, Movie Expand 16:9, Subtitle zoom or Wide screen.

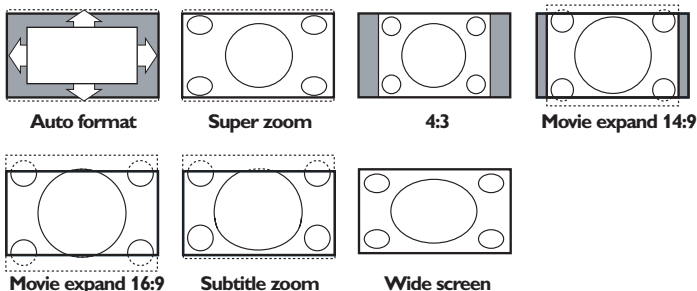

Auto format makes the picture fill the screen as much as possible. In case of subtitles in the bottom black bar, Auto format makes the subtitles visible. In case of a broadcaster logo in the corner of the top black bar, the logo disappears from the screen.

Super zoom removes the black bars on the sides of 4:3 programmes with minimal distortion.

When in Movie Expand 14:9, Movie Expand 16:9, Super zoom or Subtitle zoom picture format, you can make subtitles visible with the cursor up/down.

Note: With HD sources not all screen formats will be available.



Alphanumeric keys on the remote control

The alphanumeric keys on the remote control can be used to enter digits and text. Multi-tap entry can be used to enter alphanumeric information when necessary. The characters displayed are dependent on the language selected in the Installation menu. See p. 8. Text is entered similar to the method used for entering text messages on a cellular phone. When a letter or number has been entered, the cursor automatically advances to the next character position after the specified time out or by pressing the cursor right.

RC key	Default Multi-tap Alphanumeric entry order
1	<space> _ - 1 <space> _ - 1 (etc.)
2	a b c A B C 2 a b c (etc.)
3	d e f D E F 3 d e f (etc.)
4	g h i G H I 4 g h i (etc.)
5	j k l J K L 5 j k l (etc.)
6	m n o M N O 6 m n o (etc.)
7	p q r s P Q R S 7 p q r s (etc.)
8	t u v T U V 8 t u v (etc.)
9	w x y z W X Y Z 9 w x y z (etc.)
0	. @ 0 . @ 0 (etc.)

Also the cursor up/down can be used to enter alphanumeric information. When finished, press the **OK** key to confirm the entry. Move to the left panel.

Key	Default RC_CURSOR_UP/RC_CURSOR_DOWN Alphanumeric Entry Order
RC_CURSOR_UP	a b c d ... A B C D ... 1 2 3 ... 0 <space> _ - . @
RC_CURSOR_DOWN	@ . - _ <space> 0 9 8 7 ... Z Y X ... z y x ... c b a

Browse screen

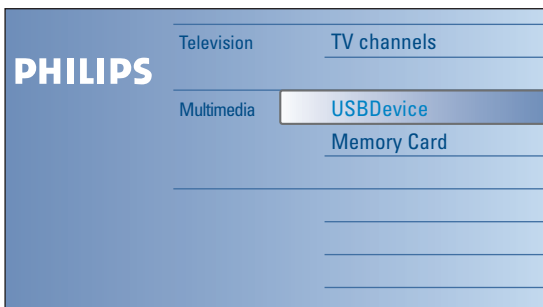

The Browse screen (and the underlying Multimedia content browser) is intended to contain all content, services, applications you are interested to consume.

- 1 Press the key to activate.
- 2 Press the cursor up/down to move the highlight up and down in the list of menu items.
- 3 Press the cursor right to go deeper into the structure.

• Television:

TV channels leading to the list of TV channels.

• Multimedia:

Contains the locally connected devices on which content (pictures, movies and audio files) is stored. See Multimedia browser, p. 20.

To use the menus

Introduction

A lot of guiding instructions, help texts and messages will be displayed on your TV when using the menus or when trying to execute an action.

Please, follow the instructions and read the help text which are being displayed on the specific item highlighted.

The colour keys refer to different actions which may be executed depending on the activated peripheral equipment. Press the corresponding colour key on the remote control to perform the required action.

Settings	TV
TV	Picture
Setup	Sound
Installation	Ambilight
Demo	Features
Exit	
Info	

Settings	TV	Picture
Picture	Personalisation tool	
Sound	Smart picture	
Ambilight	Contrast	
Features	Brightness	
	Colour	
	Sharpness	
	Tint	
Info		

How to navigate through the Settings menus

The Settings menu allows you to access and change settings and preferences.

- Press the **MENU** key on the remote control to summon the Settings menu.

- On the left panel the highlight can be set on a menu item with the cursor up/down.

The right panel shows the content of the highlighted menu item in the left panel.

Note: Sometimes not all the menu items are visible on the screen. Use the cursor down to reveal all items.

- Use the cursor right to enter the right panel.

The content of the right panel is moved to the left panel and the right panel shows the content of the newly highlighted item in the left panel.

Note: In some cases it is important that the picture can be watched while adjusting the settings. This means that when the highlight is on the right side panel, the other menu items hide away. When cursor left is pressed again, the hidden menu items re-appear and the highlight moves to the left panel.

- Press the cursor left to go one menu level up again.

- Press the **OK** key on the highlighted item to activate and to dismiss the menu.

- Press the **MENU** key again to exit the Settings menu.

Note: The menu is also dismissed by pressing one of the colour keys (if present) referring to certain actions which may be executed.

Demo

Settings	Demo
TV	Ambilight
Setup	Personalisation tool
Installation	Pixel Plus 2
Demo	Active Control
Exit	
Info	

The **Demo** menu allows the user to get an idea of the features that are part of the television.

- 1 Select **Demo** in the Settings menu and press the cursor right.

- 2 Highlight a desired demo with cursor up/down.

- 3 Press **OK** to start playing the highlighted demo.

Note: The selected demo is played once.

Press the red colour key again to exit the demo and to return to TV mode.

Note: The demos require no user interaction except for starting the demo.

Settings	
Installation	Reshuffle channels
Language	Channel name
Automatic installation
Manual installation
Reshuffle/rename channels	Channel name
Preferred channels	
Software upgrade	
Info	

Reshuffle/Rename channels

You can change the order of the stored TV channels. It is also possible to change the name stored in the memory or to assign a name to a TV channel or external for which a name has not yet been entered. A name with up to 5 letters or numbers can be given to the programme number 0 to 99 and to the externals.

- 1 Select **Reshuffle/Rename channels** in the Installation menu.
- 2 Press the cursor right. A channel list appears.
- 3 Select the TV channel you want to reshuffle or to rename with the cursor up/down.

Reshuffle

- 1 Press the green colour key on your remote control. The highlight is on the selected TV channel you want to exchange.
- 2 Select the new number you want to exchange the channel with the cursor up/down.
- 3 Press the green colour key on your remote control to swap the reshuffled channel with the currently highlighted channel.

Note: Press the red colour key to cancel the reshuffling action.

- 4 Repeat to reshuffle other TV channels.

Rename

- 1 Press the red colour key on your remote control. The highlight is on the selected TV channel you want to rename.
- 2 Select the characters with the cursor up/down or with the alphanumeric keys on the remote control.
- 3 Select the following position with the cursor right.
- 4 Enter a new character.
- 5 Press the green colour key or the **OK** key when finished.

Notes:

- Press the yellow colour key to delete all characters. The cursor will be positioned at the beginning.
- Press the blue colour key to delete the character the cursor is positioned. Enter a new character with the cursor up/down.
- Space, numbers and other special characters are located between Z and A.

- 6 Select another channel number and repeat steps 2 to 5 to do another renaming.

Settings	
Installation	Preferred channels
Language	Channel name
Automatic installation
Manual installation
Reshuffle/rename channels	Channel name
Preferred channels	
Software upgrade	
Info	

Preferred channels

After leaving the Installation, you can browse through the TV channels with the **-P+** key. Only those channels which are in the preferred list, will be displayed. In this menu you can select which channels will be part of the preferred list.

- 1 Select **Preferred channels** in the Installation menu.
- 2 Press the cursor right to display the list of stored TV channels.
- 3 Press the cursor up/down to select a TV channel you want to skip from the preferred list.
- 4 Press the **OK** key to confirm.
- 5 Repeat for every channel you want to make non-preferred.

Settings	
Installation	Software upgrade
Language	Current software info
Automatic installation	Local upgrades/applications
Manual installation	
Reshuffle/rename channels	
Preferred channels	
Software upgrade	
Info	

Software upgrade

This menu allows you to upgrade your TV software using a USB device or Memory Card device.

USB device/Memory Card upgrade

It is possible to initiate an upgrade procedure from a USB device or Memory card device before starting up the TV. The memory device must be filled with the appropriate upgrade image (and structure) which can be found on the www.philips.com/support website.

How to upload a new software version on your memory device, see Annex 1, p. 37.

Setup menu

Settings	Setup
TV	Preferences
Setup	Source
Installation	
Demo	
Exit	
Info	

Settings	
Setup	Preferences
Preferences	Picture/sound preferences
Source	Features preferences
	Menu preferences
	Factory settings
Info	

Settings/Setup	
Preferences	Picture/sound preferences
Picture/sound preferences	PIP format
Features preferences	Auto surround
Menu preferences	
Factory settings	
Info	

Settings/Setup	
Preferences	Features preferences
Picture/sound preferences	Teletext 2.5
Features preferences	
Menu preferences	
Factory settings	
Info	

This menu is used to control the settings of special TV functions, features and peripheral equipment.

The **Preferences** menu allows you to change settings that will typically be accessed only occasionally.

The **Source** menu allows you to select a source.

Preferences

- 1 Press the **MENU** key.
- 2 Select **Setup** with the cursor down and press the cursor right to select the **Preferences** menu.
- 3 Press the cursor right again to select **Picture/sound preferences**.
- 4 Press the cursor right once more to enter the Picture/sound preferences menu.

Picture/sound preferences

PIP format

This menu allows you to select the preferred format (PIP or Dual screen) which can then be displayed toggling the **12** key on the remote control **On** or **Off**.

- 1 Select **PIP format**.
- 2 Press the cursor right.
- 3 Select **PIP** or **Dual screen** with the cursor up/down. See Use of the remote control, p. 5.

Auto surround

Sometimes the broadcaster transmits special signals for Surround sound encoded programmes. The TV automatically switches to the best surround sound mode when **Auto surround** is switched **On**.

Features preferences

Teletext 2.5

Some broadcasters offer the opportunity to see more colours, other background colours and nicer pictures in the teletext pages.

- 1 Select **Teletext 2.5** in the Features preferences menu.
- 2 Press the cursor right to select **Teletext 2.5 On** or **Off**.
- 3 Select **Teletext 2.5 On** to take advantage of this feature. Select **Teletext 2.5 Off** if you like the more neutral teletext layout. The selection made is valid for all channels which broadcast Teletext 2.5.

Note: It may take a few seconds before teletext broadcast switches over to Teletext 2.5.

Settings	
Setup	Source
Preferences	AV1
Source	AV2
	AV3
	DVI
	HDMI
	Side
	Digital Audio In 1
	Digital Audio In 2
Info	

Source

This menu allows you to select the peripheral equipment you have connected to the external inputs/outputs.

- ❶ Select **Source** in the Setup menu.
- ❷ Press the cursor right.
- ❸ Select the input to which the peripheral equipment is connected.
- ❹ Press the cursor right again to enter the list of types of peripherals connected to the selected input.
- ❺ Select the peripheral equipment with the cursor up/down.

When you select **AV1**, **AV2**, **AV3**, **DVI**, **HDMI** or **Side**, a list appears allowing you to identify which type of peripheral equipment is attached to this input. The TV detects the presence of the connected peripheral equipment and the signal is routed appropriately.

Digital Audio

Select **Digital Audio In 1** or **2** when the TV expects digital audio for a connected peripheral equipment to come from a Digital audio input. Make your selection of the source to which the peripheral equipment with digital audio input has been connected.

In addition to accepting audio input via Digital Audio In, the TV can output encoded Dolby Digital audio via the **DIGITAL AUDIO OUT** connector to an external amplifier or receiver. If your amplifier or receiver has a matching connector for Digital Audio In, you can connect it with a single cable to the TV's **DIGITAL AUDIO OUT**.

See Connect Peripheral Equipment, Digital MultiChannel Surround Receiver, p. 27.

TV menu

Settings	TV
TV	Picture
Setup	Sound
Installation	Ambilight
Demo	Features
Exit	
Info	

Settings	TV	Picture
TV		Picture
Picture		Personalisation tool
Sound		Smart picture
Ambilight		Contrast
Features		Brightness
		Colour
		Sharpness
		Tint
	
Info		

Press the **MENU** key on the remote control to summon the Settings menu. The TV menu gives you an overview of the menus you can select.

Note: Depending on the input signal, one or more menu items may not be selectable.

Picture menu

Note: Some menu items are not available in case of HD sources.

- 1 Press the cursor right to select **Picture**.
- 2 Press the cursor right again to enter the Picture menu.
- 3 Select the menu items with cursor up/down.
- 4 Press the cursor right again;
- 5 Adjust the settings with the cursor keys. Select a submenu item with the cursor up/down.

Personalisation tool

The **Personalisation tool** helps you to come to a personal picture setting. This is done by presenting a series of several adjustment screens each having split screens. Each time you have to select the most preferred side of the screen. Finally a full screen appears with all the settings selected.

Note: The Personalisation tool will not alter the presence of behaviour of other picture setting options, except that it overwrites the Personal settings of Smart picture.

- 1 Select **Personalisation tool** and press the cursor right.
- 2 A welcome screen appears followed by several adjustment screens.
- 3 With the colour keys, each time select your preferred setting on the left or right screen side.
- 4 Finally press the green colour key to store your selected settings.

Smart picture

Select **Smart picture** to display a list of predefined picture settings, each corresponding with specific factory settings.

Personal refers to the personal preference settings of picture in the picture menu.

*Note: This Philips TV has been set at the factory to look best in bright shop environments which typically use fluorescent lighting. As your home will likely not be as well lit as a shop, we recommend that you cycle through the various smart picture modes to find the one that best suits your own viewing conditions. Most consumers will find that **Natural** is the correct choice.*

Contrast

This will adjust the intensity of bright parts in the picture but keep the dark parts unchanged.

Brightness

This will adjust the light output of the complete picture, which will mainly affect the darker areas of the picture.

Colour

This will adjust the saturation level of the colours to suit your personal preference.

Sharpness

This will adjust the sharpness of fine details in the picture.

Tint

This will increase or decrease **Warm** (red) and **Cool** (blue) colours to suit personal preferences.

Select **Cool** to give the white colours a blue, **Normal** to give the white colours a neutral, **Warm** to give the white colours a red tint.

Settings	
TV	Picture
Picture
Sound	Digital options
Ambilight	Dynamic contrast
Features	DNR
	Colour enhancement
	Hue
	Picture format
	Active Control
Info	

Digital options

Pixel Plus 2 is the most ideal setting, as it fully processes the image to make every single pixel the best it can be, improving contrast, sharpness, picture depth, and colour reproduction and brilliance from every source, including High Definition.

For the most optimum motion reproduction of all source materials, select the **Movie Plus** setting.

Standard mode is recommended only for very noisy or poorly mastered sources or for those who find the smoothness of Pixel Plus 2 unsettling.

Dynamic contrast

Automatically makes the contrast in the darker and the brighter picture areas more noticeable as the image on the screen changes.

Normally select **Medium**. It may be preferred to select **Minimum**, **Maximum** or **Off**.

- ➊ Press the cursor right to enter the list.
- ➋ Select one of the settings with cursor up/down.
- ➌ Press the cursor left to return to the picture menu.

DNR (Digital Noise Reduction)

Automatically filters out and reduces the image noise and improves picture quality when receiving weak video signals.

- ➊ Press the cursor right to enter the list.
- ➋ Select **Off**, **Minimum**, **Medium** or **Maximum** according to the image noise.
- ➌ Press the cursor left to return to the picture menu.

Colour enhancement

When activated, this feature automatically controls green enhancement and blue stretch. It makes the colours more vivid.

- ➊ Press the cursor right.
- ➋ Select **On** or **Off** in order to activate/de-activate Colour enhancement with the cursor right.

Hue

This compensates for the colour variations in NTSC encoded transmissions.

Picture format

This menu item performs the same as the  key on the remote control. See Use of the remote control, p. 5.

Active Control

The TV continuously measures and corrects all incoming signals in order to provide the best picture possible.

It also uses a sensor which monitors the ambient light conditions in the room and adjusts key picture settings for best viewing.

When Active Control is set to Maximum, the brightness, the contrast and the colour of the Ambilight shall be influenced by the light sensor.

When Active Control is set to Medium, only the colour of the Ambilight shall be influenced.

- ➊ Select **Active Control**.
- ➋ Press the cursor right to enter the list of Active Control values.
- ➌ Press the cursor up/down to select the Active Control values **Off**, **Minimum**, **Medium** or **Maximum**.
The picture settings are being optimised continuously. Those menu items can not be selected.
- ➍ Press the **OK** key or wait for the time out to dismiss the Active Control display.

Settings	
TV	Sound
Picture	Smart sound
Sound	Volume
Ambilight	Balance
Features	Headphone volume
	Surround mode
	Dual I-II
	Mono/Stereo
	AVL
	Delta volume
Info	

Sound menu

- ❶ Select **Sound** in the TV Settings menu.
- ❷ Press the cursor right to enter the sound menu.
- ❸ Select the menu items with cursor up/down.
- ❹ Press the cursor right.
- ❺ Adjust the settings with cursor keys.
Remember, control settings are at normal mid-range levels when the bar scale is entered.

Smart sound

Select **Smart sound** to display a list of predefined sound settings, each corresponding with specific factory settings of Treble and Bass. Press the cursor right to enter the list.

Press the cursor up/down to select a predefined sound setting.

Personal refers to the personal preference settings of sound in the sound menu.

Note: The moment you are in a predefined Smart sound setting and you modify a setting in the Sound menu, all values of the menu will overwrite the previously made personal setting.

Volume

This will adjust the sound output level.

Balance

This will adjust the output of the right and left speakers to obtain the best stereo reproduction for your listening position.

Headphone volume

This controls the level of sound through the headphones.

Surround mode

This selects the modes for more spatial or surround sound reproduction dependent on the broadcast signals or signals from external inputs received.

Dual I/II

This will select, per channel, **Language I** or **Language II**, when dual sound transmission is available.

Mono/Stereo

This selects, per TV channel, Mono or Stereo sound when analog stereo broadcasts are available.

AVL (Automatic Volume Leveler)

This automatically reduces the volume differences between channels and programmes, providing a more constant overall level. This will also reduce the dynamics of sound.

Delta volume

This allows you to correct for any permanent volume differences between TV channels or external sources.

Settings	
TV	Ambilight
Picture	Ambilight
Sound	Brightness
Ambilight	Mode
Features	Colour
	Separation
	Balance
Info	

Settings	
Ambilight	Mode
Ambilight	Colour
Brightness	Ambience
Mode	Relaxed
Colour	Movie
Separation	Action
Balance	
Info	

Settings	
Ambilight	Colour
Ambilight	Smart colour
Brightness	Palette
Mode	Saturation
Colour	
Separation	
Balance	
Info	

Smart colour modes:

- **Personal:** Select any colour or hue to match to your personal taste, e.g. your interior, the programme content (sports, movie, etc.), the mood you are in, etc.
- **Warm white:** The colour is matched to that of most normal lightbulbs. Select this setting if you want the Ambilight to fit best with normal living room lighting.
- **Cool white:** The colour is matched to that of normal daylight (6500K). Select this setting if you prefer more cool lighting.
Note: the 6500 K is the SMPTE recommended setting for ambient backlighting of displays.
- **Blue:** The blue colour is preferred by most consumers to create a cool, modern and /or mystical atmosphere. Select this setting according to your personal taste or mood.

Ambilight menu

Ambilight is an innovative lighting concept using light with fully adjustable colours at the back of the TV to enhance the viewing experience. Analysis of the picture content adapts the colours continuously, or the lights can be set to any fixed colour and many shades of white. Ambilight creates the ideal viewing environment for your TV resulting in improved relaxed viewing, improved perceived picture detail, contrast and colour.

In standby mode the lights can be set/operated to any colour and create a unique ambience in the room.

- 1 Select **Ambilight** in the TV menu.
- 2 Press the cursor right to enter the Ambilight menu.
- 3 Select Ambilight and press the cursor right to select **Off** or **On**.
 - **Off:** will switch off the ambient lights and downlight all other ambilight menu items.
 - **On:** the ambient lights will be on. Refine the light settings in the menus below.
- 4 Select **Brightness** to adjust the light output of the ambient lights.
- 5 Select **Mode** and press the cursor right to select **Colour**, **Ambience**, **Relaxed**, **Movie** or **Action**.
 - **Colour:** this will show constant light according to the settings in the Ambilight colour menu. See below.
 - The options **Ambience**, **Relaxed**, **Movie** and **Action** will dynamically match brightness and colour to the screen content. The mode selection made will effect the speed and/or saturation and/or intensity which determines the viewing impression. E.g. in **Relaxed** mode, the rate of brightness and colour change is smoothly and soft which gives you a more immersive yet relaxed viewing. **Ambience** is the rate of brightness and colour change as predefined in the factory. **Movie** will influence the perception of a movie whereas **Action** mode will influence the dynamic impression.

Notes:

- The rate of change is limited, as not to cause uncomfortable sensations.
- According to the selection made, some Ambilight menu items will be downlighted and can not be selected.

- 6 In case **Colour** has been selected in the Mode menu:
 - Select **Colour** in the Ambilight menu and press the cursor right.
 - Select **Smart colour** and then select **Personal**, **Warm white**, **Cool white** or **Blue**.
 - Select **Palette** to select the general colour of the light output.
 - Select **Saturation** to adjust the colourfulness of the light.

Notes:

- Adjusting the Palette and/or Saturation settings will set the colour mode to Personal.
- The selected colour mode will be the one used when turning on the ambient lights from standby mode.

- 7 In case **Ambience**, **Relaxed**, **Movie** or **Action** has been selected in the Mode menu:
 - Select **Separation** in the Ambilight menu and press the cursor right.
 - Select **Off** for a mono behaviour which means that all lamps will behave equally.
 - Select **Minimum**, **Medium** or **Maximum** to define the Ambilight stereo effect over the available lamps.
- 8 Select **Balance** and use the cursor left/right to adjust and generate any colour and level of light intensity on the left and right side of the picture to perfectly match your room setup.

Ambilight in Standby mode

When the TV is switched off, the ambient lights will also be switched off. When the TV is in standby mode, ambilight can be used to provide a unique ambience for the room. Press the **AMBILIGHT ON/OFF** key on the remote control (see p. 4) to switch between Ambilight Off or On.

Note: Infrared interference

To avoid bad infrared remote control reception, place your peripheral equipments out of sight of the ambient lights of your TV.

Note: Ambilight does not function well when the room temperature is less than 59°F/15°C.

Multimedia Browser

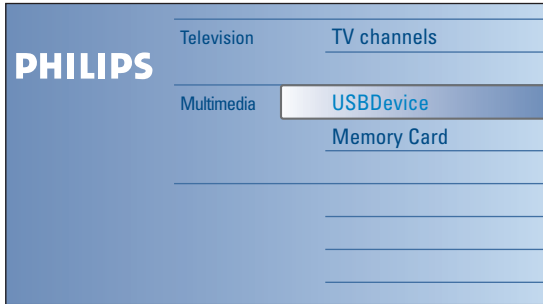

The Multimedia browser lets you display pictures, audio or movies or play audio files stored on a USB device or a memory card. The Multimedia browser application is invoked from the Browse menu (press the key) by selecting a device and pressing the cursor right.

Notes:

- Following types of memory cards can be read:
Compact Flash I & II, Memory stick, Memory stick PRO, SD Card/Mini SD Card, Smart Media, Micro Drive, MultiMedia Card.
- Following file formats can be reproduced:
 - For pictures: JPEG
 - For audio: MP3, MP3 Pro
 - For video: MPEG1, MPEG2, MPEG4, DIVX and XVID files
- Only FAT/DOS-formatted memory devices are supported.
- If your digital camera is not supported, try one of the following solutions:
 - Make sure your camera is switched on and verify if its configuration settings are correct (see the manual of your camera).
 - Remove the memory card from your camera and insert it in the memory card slot. Refer to www.philips.com/support for more information.
- Philips cannot be responsible if your USB device or memory card is not supported.

Viewing content from a Memory card / USB device

Inserting a memory card / USB device

Note: Memory cards or USB devices are not supplied with this TV.

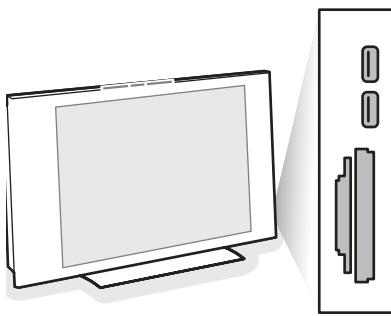

Insert a memory card in one of the cardslots at the right side of the TV. Insert it to be clicked in. In case of a memory stick or a digital camera, connect it to one of the USB2.0 connectors. When a memory card or a USB device is inserted, the Multimedia menu is displayed automatically, see further.

Removing the memory card / USB device

- 1 First switch off the Browse menu. To do so, press the key on the remote control.
- 2 Remove the memory card/USB device.

Card data protection

- Do not remove the card/USB device when the content is being read or when browsing. Such action may damage the memory card/USB device.
- Do not touch the terminals on the back of the card.
- Always insert a card in the correct direction. Failure to do so may result in damage to the card and the unit.
- Do not subject the card to excessive pressure or strong impacts.
- Malfunctions of the unit or card may result in data loss or damage to the card.
- Philips shall not accept any liability for damage or loss of stored data.

Warning:
Memory cards can be swallowed by young children. Do not allow children to handle memory cards. Please, remove the memory card immediately after use.

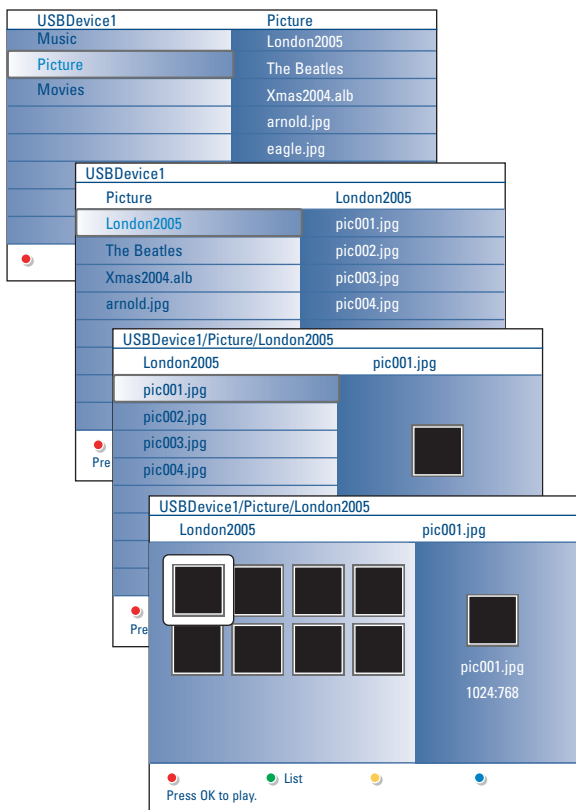





Multimedia Browser menu

- 1 Insert a USB device or memory card.
- 2 Select the USB device or memory card under Multimedia with the cursor up/down.
The Multimedia browser will allow the user to browse content stored on the inserted USB device or memory card.
Press the cursor right.
- 3 The 2-panel browser will be shown with the left panel containing the content types (Music, Picture, Video).
The right panel will display the content that is available of the selected content type.
- 4 Press the cursor up/down to select a content type and press the cursor right to enter the content.
- 5 Press the cursor up/down to select a file or a directory.
Note: Press the green colour key to display all the image files in the current directory as thumbnails when browsing pictures. Press the green key again to display the image files in a list.
- 6 In case a **file** is selected, press the **OK** key to display a picture file or to play an audio file.
In case a directory, album or playlist is selected, press the cursor right to enter the content or press the **OK** key to start a slide show or a loop playback of the files present in the directory, album or playlist.
- 7 Press the cursor left to keep music playing and switch back to the Multimedia menu.
- 8 Press one of the colour keys on the remote control to perform the corresponding function mentioned at the bottom of the screen.
The blue colour key can be used to let the colour re-appear.
- 9 To stop playing content, press the **■** key on the remote control.

Notes:

- **Your TV supports slide shows with background music.** See Annex 2, p. 36.
- The playback will continue to play even if temporarily switched to browser screens. The audio will be stopped when another song starts playing, or when the end has been reached.
- The length of the files should not exceed 128 characters.
- More technical remarks can be found in Annex 3, p. 38.

Following icons may appear:

-  folder
-  pictures
-  music
-  self made playlist/album
-  video

Function keys at the bottom of the screen

- | | |
|--------------------------|--|
| Details | to display a description of the selected file or directory; |
| Transitions | to select if a transition during a slide show should be applied; |
| Slide time | to select the duration a picture will be displayed in a slide show; |
| Rotate | to rotate a picture; |
| Repeat one/all | to repeat the playback of a music file; |
| Shuffle | to shuffle music collections in a random way; |
| Zoom | to select one of the zoom magnifications (x1, x2, x4) with the cursor keys up/down.
Additionally you can shift the selected zoom window over the screen with the cursor keys; |
| Full/small screen | to toggle between a full or a small screen. |

Note: To rotate a picture or to select one of the zoom magnifications, first stop the slideshow with the OK key or the blue colour key.

Other function keys on the remote control

- to stop displaying content;
- ||** to pause displaying content;
- ▶** to play a single file, start a slide show, playback of a folder or other collection;
- ▶▶** to fast forward displaying content.
- ◀◀** to fast rewind displaying content.

Teletext



Most TV channels broadcast information via teletext. This TV has a 1200 pages memory that will store most broadcasted pages and subpages to reduce waiting time. After each programme change, the memory is refreshed.

Switch Teletext on and off

Press to switch the teletext on.

Select a Teletext page

- Enter the desired page number with the digit keys or with the **-P+** key.
- Select the options at the bottom of the screen with the colour keys.

Previously selected teletext page

Press the P+P key.

Select the index teletext page

Press the grey colour key to display the main index (usually p.100).

Only for T.O.P teletext broadcasts:

Press . A T.O.P overview of the teletext subjects available is displayed. Select with the cursor up/down, left/right the desired subject and press the **OK** key.

Not all TV channels broadcast T.O.P. teletext.

Select subpages

When a selected teletext page consists of different subpages, a list of available subpages appears on the screen.

Press the cursor left or right to select the next or previous subpage.

Picture/Teletext

- 1 Press the key. Press the key to show Teletext on the right of the screen.
- 2 Press the key to return to a full teletext picture.
- 3 Press the key to return to a full screen picture.

Enlarge a Teletext page

Press repeatedly to display the upper teletext part, the lower teletext part and then to return to the normal teletext page size. When the teletext page is enlarged, you can scroll the text, line by line using the cursor up/down.

Hold

Press the key to stop the pagecounter from seeking when you have entered a wrong pagenumber or when the page is not available. Enter another page number.

Hypertext

With hypertext you can quickly jump to a pagenumber or search for a specific word shown on the current teletext page.

- 1 Press the **OK** key to highlight the first word or a number on the page.
- 2 Use the cursor up/down, left/right to select any other word or number you want to search for.
- 3 Press the **OK** key to confirm. The search starts. A message appears at the bottom of the screen to indicate the searching, or that the word or page is not found.
- 4 Use the cursor up to exit hypertext.



Teletext menu	
Reveal	Off
Cycle subpages	Off
Language	Group II

Teletext menu

The Teletext menu offers various functions to control teletext.

- 1 Switch teletext on and press the **MENU** key to activate the menu.
- 2 Press the cursor up/down to select the menu items.
- 3 Press the cursor right or the **OK** key to activate.
- 4 Press the **MENU** key to leave the teletext menu.

Reveal

Reveals/conceals hidden information on a page, such as solutions to riddles and puzzles.

Cycle subpages *(if subpages are available)*

Makes the subpages cycle automatically.

Press the cursor right or the **OK** key to activate and to deactivate again.

Language

If the displayed characters on screen do not correspond with the characters used by the teletext broadcaster, you can change the language group here. Select **Group 1** or **Group 2** with the cursor right.

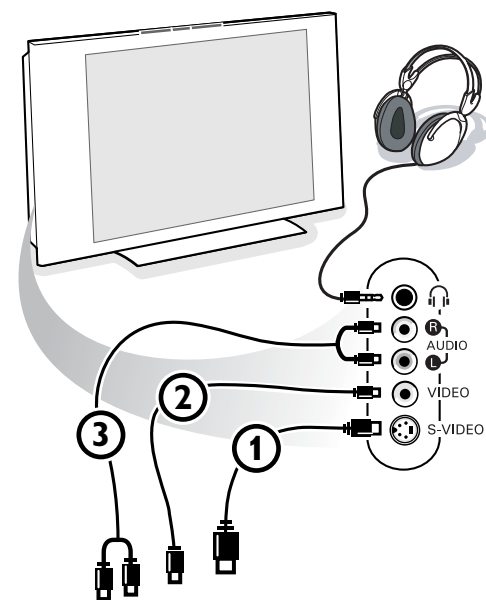

Equipment to connect to the side connections



Camera, Camcorder, Game

- 1 Connect your camera, camcorder or game as shown.
- 2 Connect to **VIDEO** ② and **AUDIO L** ③ for mono equipment. For stereo equipment also connect **AUDIO R** ③. S-VHS quality with an S-VHS camcorder is obtained by connecting the S-VHS cables with the **S-VIDEO** input ① and **AUDIO** inputs ③. *Do not connect cable ① and ② at the same time. This may cause picture distortion!*

Headphone

- 1 Insert the plug into the headphone socket  as shown.
- 2 Press  on the remote control to switch off the internal loudspeakers of the TV. *The headphone impedance must be between 8 and 4000 Ohm. The headphone socket has a 3.5 mm jack.* In the Sound menu select **Headphone volume** to adjust the headphone volume.

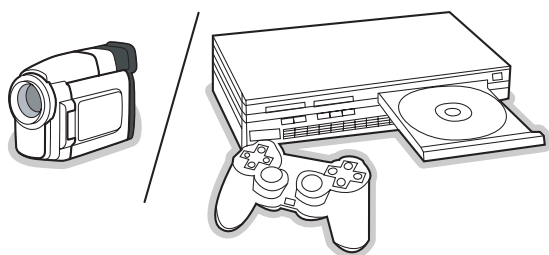

Connect Peripheral Equipment

There is a wide range of audio and video equipment that can be connected to your TV.
The following connection diagrams show you how to connect them.

Note:

AV1 can handle YPbPr, S-VIDEO, RGB + HV or VIDEO and L/R Audio;

AV2 VIDEO or S-VIDEO and L/R Audio;

AV3 YPbPr and Digital Audio;

DVI (analogue and digital) and **HDMI** (digital);

Side VIDEO or S-VIDEO and L/R Audio.

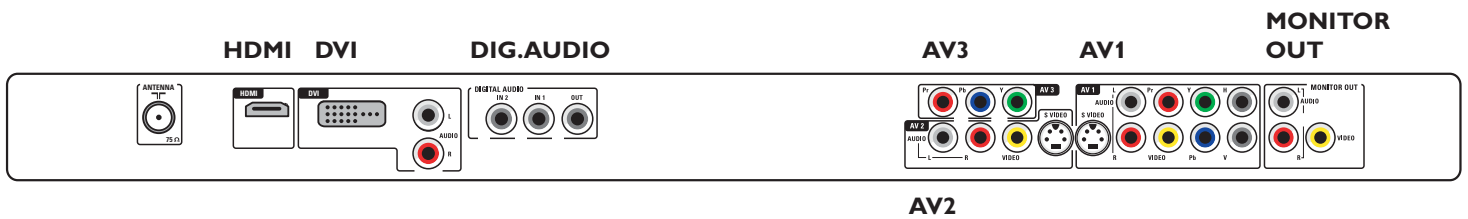
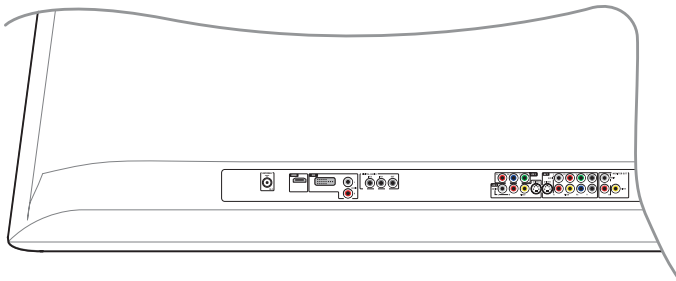

AV2

Recorder (VCR-DVD+RW)

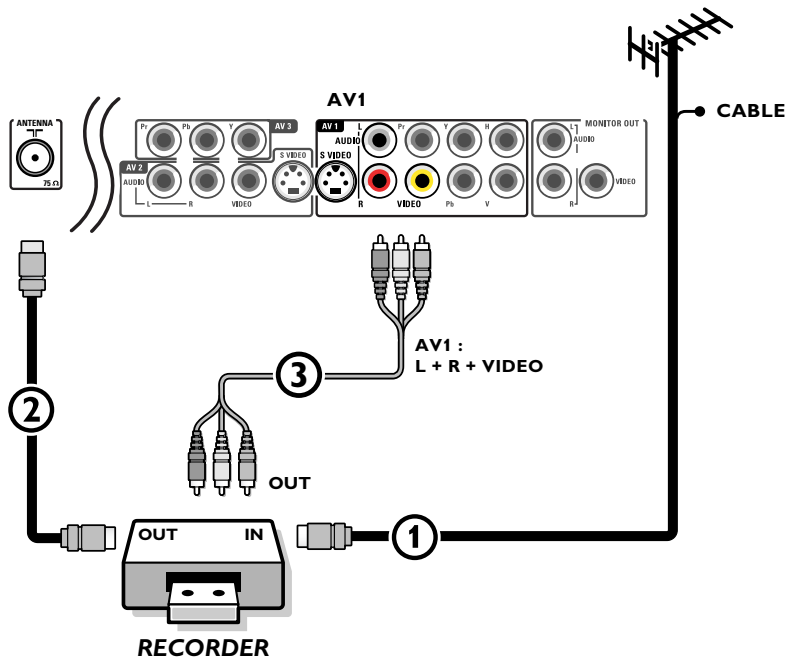

Note: Do not place your recorder too close to the screen as some recorders may be susceptible to signals from the display. Keep a minimum distance of 0,5 m from the screen.

- 1 Connect the RF Antenna cable ① to the **RF IN** socket of your recorder.
- 2 Connect another RF cable ② from the output **OUT** of your recorder to the TV's input **CABLE/ANTENNA 75 Ω** jack.
- 3 Better playback quality can be obtained if you also connect the Video, Audio Left and Right (only for stereo devices) AV cables ③ to the **VIDEO, AUDIO L** and **R** input jacks of **AV1**.

If your recorder has an S-VHS video jack:

For improved picture quality, connect an S-video cable with the **S-VIDEO** input instead of connecting the recorder to the **VIDEO** jack of **AV1**.

S-Video does not provide audio, so audio cables must still be connected to provide sound.

Recorder and other equipment

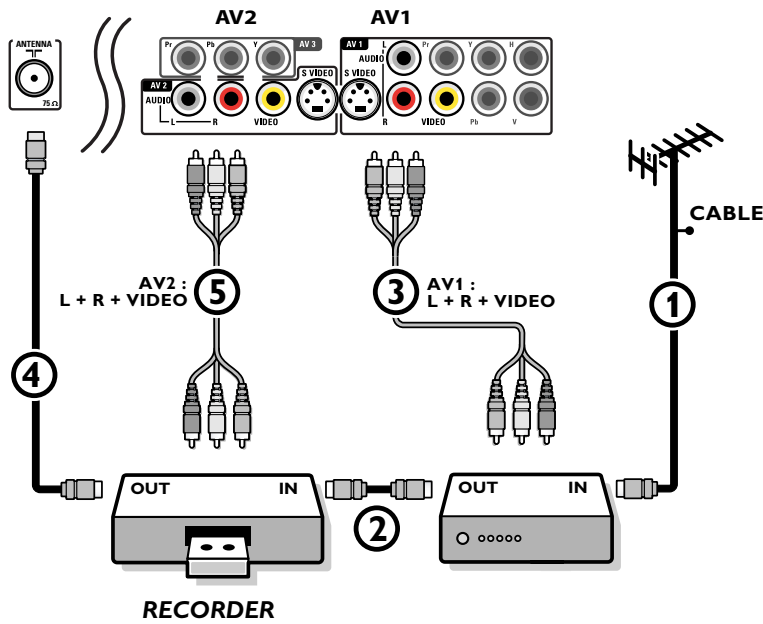

- ① Connect the RF antenna cable ① of the **RF IN** socket of your other AV device.
- ② Connect the RF output of the AV device to the RF input of the recorder ②.
- ③ Connect another RF cable ④ from the output **OUT** of your recorder to the TV's input 75 Ohm jack.
- ④ To obtain better picture quality, also connect the Video or S-Video, Audio left and Audio right cables of both devices to **AV1** (**VIDEO** or **S-VIDEO**, **AUDIO L** and **R**), ③ and to **AV2** (**VIDEO** or **S-VIDEO**, **AUDIO L** and **R**) ⑤.

Notes:

- In case of mono equipment, only the left loudspeaker reproduces sound. Use a mono to stereo adaptor (not supplied) for sound reproduction via all internal loudspeakers.
- When using the **S-VIDEO** connector do not connect any device to the **AV2 VIDEO** or **AV1 VIDEO** input.

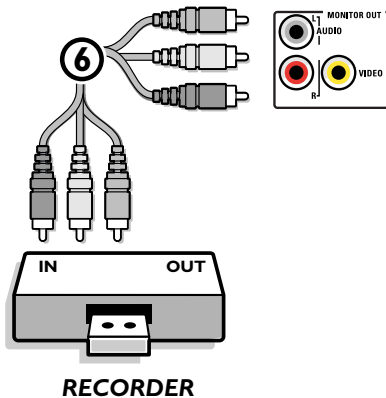

The **MONITOR OUT** connector can be used for a daisy chaining or to record programs from your TV ⑥. Only when a recorder is connected to **MONITOR OUT** it is possible to record an analog program from your TV. See Record with your recorder, p. 30.

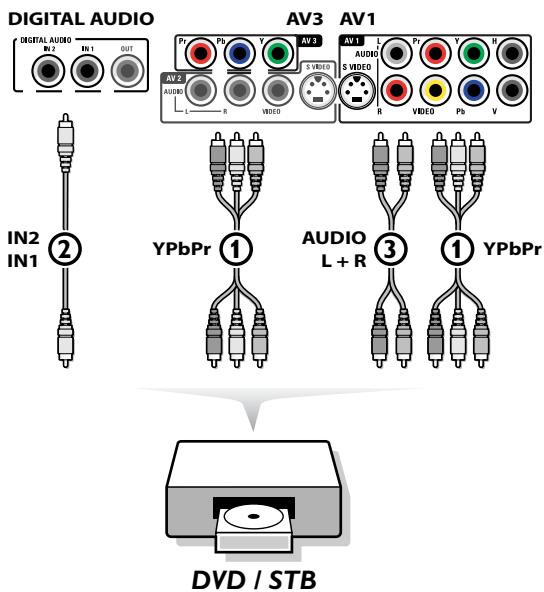

DVD Player or other accessory digital source equipment

Devices with Component Video Output Connectors (YPbPr)

This TV is capable of displaying 1080i, 720p, 576p and 480p DTV signals when connected to a DTV tuner Set Top Box. Select the output of the Set Top Box to either 1080i, 720p, 576p or 480p. A DTV signal must be available in your area.

- Connect the three separate component video cables ① to the device having component video outputs (YPbPr), such as Set Top Boxes, DVD-players, laser-disc players, videogame players, satellite receivers or other equipment, and to the **Y, Pb** and **Pr** jacks of **AV1** or **AV3** on the TV.
 - Connect to the **Y, Pb** and **Pr** jacks of **AV1** in case of devices with analog audio signals.
 - Connect to the **Y, Pb** and **Pr** jacks of **AV3** in case of devices with digital audio signals.
- In case of a device with digital audio, connect the audio cable ② to the **DIGITAL AUDIO OUT** of the device and to the **DIG. AUDIO IN** of the TV or to your Home Cinema system.
In case of a device with analog audio, connect the audio cable to the device's **AUDIO L** and **R** ③ jacks and the **L** and **R** audio jacks of **AV1**.

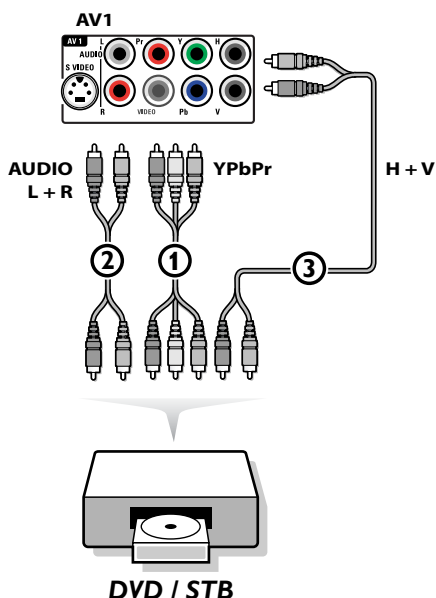

Devices with RGB output

- Connect the device with RGB output with separate Horizontal and Vertical sync to the **Pr/R Pb/B Y/G** input ① jacks and to the **H** and **V** jacks of **AV1** ②.
- Connect the audio cables to the **L** and **R** **AUDIO** jacks of **AV1** ③.

Devices with an S-Video connector

- Connect an S-Video cable to the **AV1** or **AV2 S-VIDEO** input ①.
*Note: When using the S-VIDEO connector do not connect any device to the **AV2 VIDEO** or **AV1 VIDEO** input that you are using.*
- Connect the audio cables to the device's **AUDIO L** and **R** jacks and to the **L** and **R** audio **AV1** or **AV2** jacks ② on the TV accordingly to where you connected the S-Video cable.

Notes

- If necessary, you can adjust the picture position to the center of the screen with the cursor keys.
- The labels for the component video sockets may differ depending on the DVD player or the device connected. Although the abbreviations may vary, the letters **B** and **R** stand for the blue and red component signals, respectively, and **Y** indicates the luminance signal. Refer to the DVD player's or devices instructions for use for definitions and connection details.
- This television is designed to accept high definition signal standards 480p, 576p, 720p and 1080i as specified by the Electronic Industries Association standard EIA770.3.
Digital devices from different manufacturers have the possibility of differing output standards which may cause difficulties for the television to properly display.
- Due to possible digital image distortion when displaying signals from connected digital equipment, automatically the Auto picture setting **Soft** is selected, if you selected Digital STB in the Source menu. See Picture menu, Auto picture, p. 19. Changing this setting during reviewing will not be stored as **Personal** setting after switch off.

Warning: in case you notice scrolling images, wrong colors or no color, no picture, or even combinations of these on your screen, check if the connections are done in the correct way or move your digital device further away from your TV.

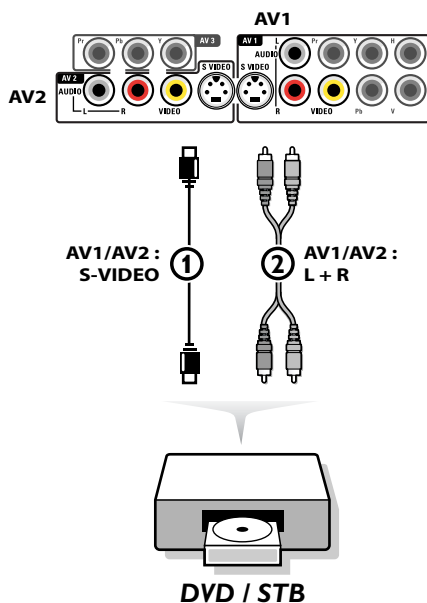

MultiChannel Surround receiver

- Digital MultiChannel Surround receiver

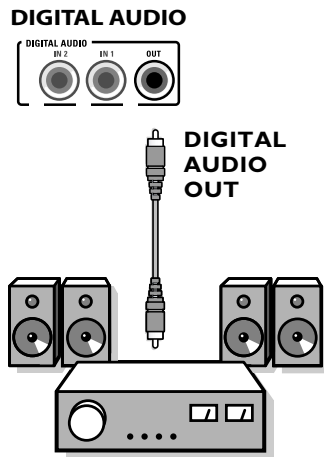

Connect a digital MultiChannel Surround receiver to the **DIGITAL AUDIO OUT** connector at the bottom of the TV.

Devices to connect to a HDMI (High Definition Multimedia Interface) connector

HDMI is the leading new standard for Digital video and audio interconnection.

To the **HDMI** connector you can connect HDMI peripheral equipments such as compatible DVD-R or DVD player with HDMI. So you can display high-definition pictures on this TV in the digital form.

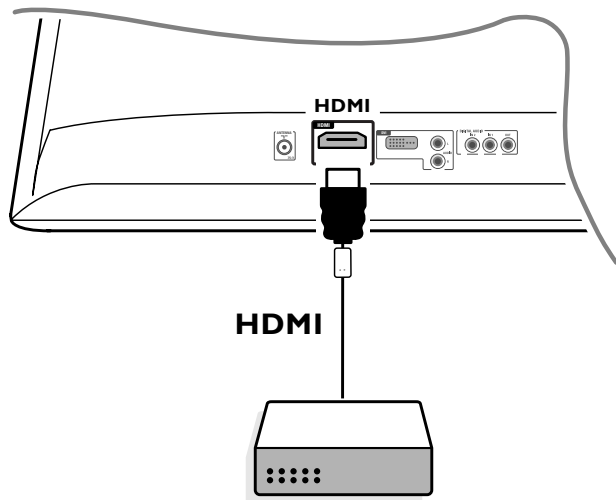

- ❶ Connect your HDMI equipment with the **HDMI** connector.
- ❷ Select the connected digital peripheral equipment in the Setup, Source menu, p. 13.

The **HDMI IN** connector allows the following TV and monitor display modes:

HD	Standard Definition TV (SDTV)	640x480i 720x480i 720x576i
	Enhanced Definition TV (EDTV)	640x480p 720x480p 720x576p
	High Definition TV (HDTV)	1920x1080i 1280x720p
PC	VGA	640x480
	SVGA	800x600
	XGA	1024x768

Notes:

- If necessary, you can adjust the picture position to the centre of the screen with the cursor keys.
- Due to legal requirements, it is possible that with certain copy protected PCM audio qualities from a peripheral equipment connected to the **HDMI** input, the Digital audio output signal is muted.
- Your TV supports HDCP (High-bandwidth Digital Content Protection). This is a system for protecting DVD content outputted via DVI from being copied. It provides a secure digital link between a video source (DVD, PC, etc.) and your TV. Content is encrypted at the source peripheral equipment to prevent unauthorised copies from being made.
- Proper working is only guaranteed with HDMI compliant consumer products.
- Digital peripheral equipments from different manufacturers have the possibility of differing output standards which may cause difficulties for the television to properly display.
- In case no signal is detected from your HDMI equipment, switch off the HDMI equipment and then on again.
To get an optimal viewing, it is advised to switch your DVD player to one of the following TV display standards: 1920x1080i, 1280x720p, 720x576i, 720x576p, 720x480i, 720x480p.

Devices to connect to a DVI connector

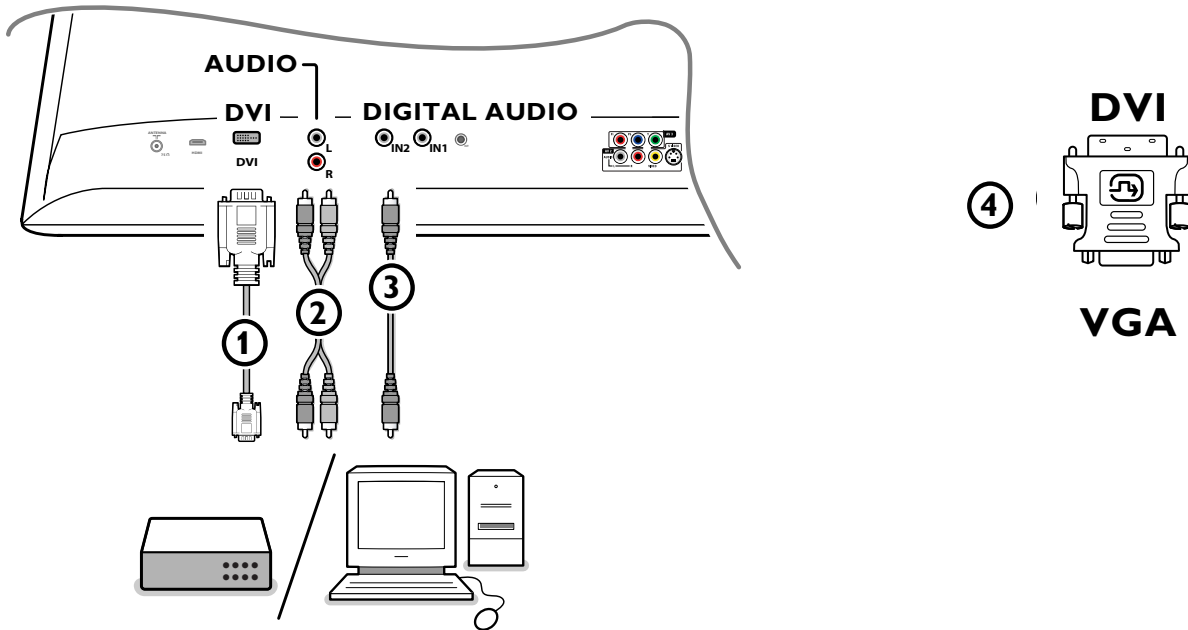

The **DVI** connector allows the following TV and monitor display modes, via the  key on the remote control, for High Definition (HD) and computer (PC) equipment:

HD	Standard Definition TV (SDTV)	640x480i 720x480i 720x576i
	Enhanced Definition TV (EDTV)	640x480p 720x480p 720x576p
	High Definition TV (HDTV)	1920x1080i 1280x720p
PC	VGA	640x480
	SVGA	800x600
	XGA	1024x768

Note: If necessary, you can adjust the picture position to the centre of the screen with the cursor keys.

- ❶ Connect your equipment to the **DVI** connector of your TV ❶.
According to the type of connector of your equipment, you may have to use an appropriate adapter.
 - DVD**
Connect the DVI to DVI cable to the **DVI** connector of your TV ❶.
 - Computer (PC):**
 - with a DVI connector: connect the DVI to DVI cable to the **DVI** connector of your TV ❶.
 - with a VGA connector: connect the VGA cable to a VGA to DVI adapter ❷ and connect to the **DVI** connector of your TV ❶.
 - ❷ Connect the audio cable ❷ to the **DVI AUDIO R** (right) and **L** (left) inputs of the TV when the TV expects analogue audio for a connected peripheral equipment to come from an analogue audio input
- OR**
- Connect the audio cable ❸ to one of the **DIGITAL AUDIO IN** connectors of the TV when the TV expects digital audio for a connected peripheral equipment to come from a digital audio input.
Then also make your selection of the source to which the peripheral equipment with digital audio input has been connected in the Setup, Source menu. See Digital audio, p. 14.

Record with your recorder



Record a TV programme

You can record a TV programme using your recorder's tuner without affecting your TV.

- 1 Select the channel number on your recorder.
- 2 Set your recorder to record.
See the handbook for your recorder.

Switching channel numbers on your TV does not disturb recording!

Record a programme from MONITOR OUT

You can record a programme on your recorder from the TV tuner via **MONITOR OUT**.

- 1 Switch on the device.
- 2 Select the channel or wanted device on your TV and the correct input on your recorder.
- 3 Set your recorder to record.
You record the tuner channel of the TV or selected device.

*Do not switch channels or turn off your TV when you are recording through **MONITOR OUT**.*

To select connected peripherals

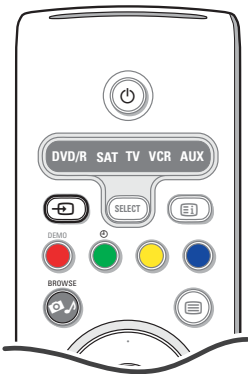

- 1 Press the  key and then press this key repeatedly or select **Source** in the Set up menu (see p. 13) to select **AV1, AV2, AV3, HDMI, DVI, Side** or **TV**, according to where you connected your peripheral equipment.
- 2 Press the cursor up/down.
- 3 Press **OK**.

Audio- and video equipment keys



Most of the audio and video equipment from our range of products can be operated with the remote control of your TV.

Normal mode

Press one of the keys after you pressed the **SELECT** key repeatedly according to the equipment you want to operate with this remote control. See Use of the remote control, p. 4.

- | | | | |
|----|---|-------------------|---|
| ⏻ | to switch to standby | 0 to 9 | digit entry, |
| ⏸ | for pause, | cursor up/down | to select the next or the previous disc (CD) |
| ● | for record, | cursor left/right | to select the previous or following track (CD) |
| ⏮ | for rewind (VCR, CD); search down (DVD) | P+P | to select a DVD title/chapter; index (AUX) |
| ■ | for stop, | ☰ | to select your choice of subtitle language (DVD) |
| ▶ | for play, | | |
| ⏭ | for fast forward (VCR, CD); search up (DVD) | | |
| i+ | to display information | | |
- MENU** to switch the menu on or off
- **P +** for chapter, channel, track selection

Notes:

- If no action is being undertaken within 60 seconds, the remote control returns to TV mode.
- After an action in the selected system mode, the remote control will remain in this mode for 60 seconds and will then return to TV mode or press the **SELECT** key to return to TV mode immediately.

Expert mode

When you do not want the remote to go back to TV mode, and to stay in the mode selected, proceed as follows:

- 1 Select **TV** mode with the **SELECT** key.
- 2 Press the **SELECT** key again simultaneously with the **OK** key for at least 2 seconds.
- 3 Select the desired mode with the **SELECT** key.

The remote will not go back to TV mode from now on and will remain in the mode selected. To go back to the default setting of the remote (TV mode) repeat what is explained above, selecting the TV mode.

Note: LED behaviour

- If the LED blinks **once** after pressing the **SELECT** key simultaneously with the **OK** key for at least 2 seconds, the remote control is in **Expert mode** and the remote control remains in the mode selected.
- If the LED blinks **4 times** after pressing the **SELECT** key with the **OK** key for at least 2 seconds, the remote control is in **Normal mode** and the remote control returns to TV mode after 60 seconds.

Direct selection of a connected peripheral equipment

When the remote is in **TV Expert mode** you may directly select a connected equipment in the following way:

Press:

- The **☰** key followed by digit '1' to select the device connected to **AV1**.
- The **☰** key followed by digit '2' to select the device connected to **AV2**.
- The **☰** key followed by digit '3' to select the device connected to **AV3**.
- The **☰** key followed by digit '5' to select the device connected to **DVI**.
- The **☰** key followed by digit '6' to select the device connected to **HDMI**.
- The **☰** key followed by digit '0' to select the device connected to the side.

Note: Make sure your equipment is switched on.

Setting the remote control to work peripheral equipment

Your TV remote control gives you the opportunity to control all your peripheral equipments with one single remote control. This can be done by selecting the correct brand and type out of the list of Direct Entry codes for peripheral equipments.

Press the **SELECT** key repeatedly to select **DVD/R**, **SAT**, **VCR** or **AUX** according to the peripheral equipment you want to operate with this remote control. See Use of the Remote control, p. 4. If the function keys on the remote control also work the selected peripheral equipment, then the remote is ready and no further steps are needed.

If the function keys do not work with the selected peripheral equipment, according to the equipment(s) you own, you may make your remote control ready for them by a direct entry code. Proceed as following.

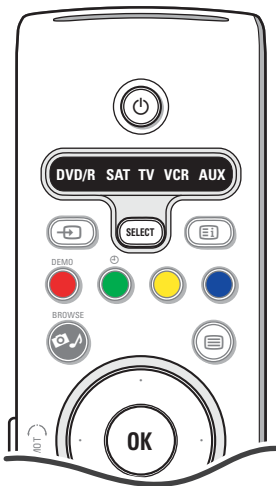

Code setup

- 1 Press the **SELECT** key repeatedly to select your source according to the peripheral equipment you want to operate with this remote control.
- 2 Press the **SELECT** and **⏻** key at the same time for longer than 4 seconds. The selected mode LED will lit constantly.
- 3 Input the 3-digit code for the type and brand of peripheral equipment. The codes are listed on page 33.
- 4 The selected mode LED will blink fast for 5 seconds as a confirmation you entered a correct code. The remote will go back to the last selected mode. If you entered a wrong code the mode LED will stay on for 2 seconds. Redo step 3.
- 5 Now you will try to use the TV remote with the peripheral equipment. Press the **SELECT** key repeatedly to select the desired mode. The selected mode LED will stay on for 2 seconds and then begin blinking. The blinking means that the remote is in the external mode you have selected.
- 6 Within 60 seconds from the time the blinking starts, point the remote toward the peripheral equipment and press the **⏻** key. If the peripheral equipment does not respond to the **⏻** command, follow the steps for programming the remote again using a different setup code for the type and brand of peripheral equipment you wish to operate. Refer again to the code list on page 33. If no more codes are listed for the type and brand of external equipment, the remote likely will not operate your particular model of peripheral equipment.

Notes:

- Your TV remote is not necessarily capable of being programmed to operate all models of the brands of peripheral equipments listed on page 33. You may want to try the programming process again. Try using the number(s) that are listed for your type and brand of peripheral equipment to be sure you did not make a mistake in inputting the digits during your first attempt at programming.
- If the remote control is in one of the external modes (a mode light is flashing) — DVD/R, SAT, VCR or AUX — and you don't press any of the remote keys for sixty seconds, a "time-out" occurs, returning the remote to TV mode.

To cancel the selected mode

- Press the **SELECT** key for 2 seconds.
The remote control will return to TV mode.

Remote Control Direct Entry Codes for Peripheral Equipment

CD			
Bose.....	512		
Hitachi.....	501		
JVC.....	504		
Kenwood.....	502		
Panasonic.....	505		
Philips.....	500		
Pioneer.....	511		
Samsung.....	506		
Sharp.....	507		
Sony.....	508		
Technics.....	509		
Thomson.....	503		
Yamaha.....	510		
Digital Video Disc (DVD)			
Aiwa.....	502		
Alba.....	503, 504		
Bush.....	505		
CyberHome.....	506, 507		
Daewoo.....	508		
Dansai.....	509		
Denon.....	543		
Goodmans.....	510		
Grundig.....	511, 512		
Hitachi.....	513		
JVC.....	514, 515		
Kenwood.....	540		
LG.....	516, 517, 518		
Mustek.....	519, 544		
Panasonic.....	520, 522, 523, 541		
Philips.....	500, 524		
Pioneer.....	525		
Samsung.....	526, 527, 528		
Sanyo.....	529		
Scott.....	530		
SEG.....	531, 532		
Sharp.....	533		
Sony.....	534, 535, 536		
Thomson.....	501		
Toshiba.....	537, 538		
Yamaha.....	539		
Satellite Receiver			
Akai.....	500		
Alba.....	501, 502, 503		
Allsat.....	500		
Amstrad.....	505, 524		
Ankaro.....	507		
Anttron.....	501, 503		
Apollo.....	501		
Armstrong.....	505		
Asat.....	500		
Astra.....	505		
Astro.....	503, 504, 507, 510		
Audio Ton.....	503		
Best.....	507		
Blaupunkt.....	510		
Brain Wave.....	511		
BSkyB.....	524		
Bush.....	502, 512		
CityCom.....	502		
Clatronic.....	511		
Condor.....	507		
Crown.....	505		
Daeryung.....	509		
DNT.....	500, 509		
Echostar.....	509, 515		
Einhell.....	501, 505		
Elta.....	500, 501, 507		
Emme Esse.....	507, 512		
Ep Sat.....	502		
Eurosat.....	505		
Eurosky.....	505, 507		
Eurostar.....	505		
Ferguson.....	502, 512, 519		
Finlandia.....	502		
Finlux.....	502		
Fuba.....	500, 501, 507, 509, 510		
Galaxis.....	507		
GMI.....	505		
Goodmans.....	502		
Grundig.....	502, 503, 510, 512, 518, 524		
Hanseatic.....	513		
Hirschmann.....	510		
Hisawa.....	511		
Hitachi.....	502, 512		
Huth.....	505, 511		
Intertronic.....	505		
Johansson.....	511		
Kathrein.....	500, 510, 520		
KR.....	503		
Kreiselmeier.....	510		
Kyostar.....	501		
Lasat.....	504, 507		
Lenco.....	501		
Macab.....	519		
Manhattan.....	502, 504, 512		
Marantz.....	500		
Mascom.....	504		
Maspro.....	502, 512		
Mediamarkt.....	505		
Medion.....	507, 513, 515, 516		
Metronic.....	501, 503, 504, 522		
Metz.....	510		
Minerva.....	510		
Mitsubishi.....	502, 510		
Morgan's.....	500, 505		
Nikko.....	505		
Nokia.....	502, 512, 514		
Nordmende.....	501, 502, 504, 519		
Novis.....	511		
Octagon.....	501, 503		
Okano.....	505		
Orbitech.....	501		
Otto Versand.....	510		
Pace.....	502, 510, 512, 524		
Palladium.....	505		
Panasonic.....	502, 512, 524		
Panda.....	502		
Philips.....	500, 502, 506, 512, 517		
Phonotrend.....	502		
Predki.....	511		
Provision.....	504		
Quadral.....	507		
Quelle.....	510		
Radiola.....	500		
Radix.....	509		
RFT.....	500		
Saba.....	504, 512		
Sabre.....	502		
Sagem.....	519		
Samsung.....	501		
Satcom.....	511, 513		
SatPartner.....	501, 503, 504, 511		
Schneider.....	507, 515, 516		
Seemann.....	505, 509		
SEG.....	501, 507, 511, 513, 523		
Siemens.....	510		
Skymasters.....	513, 515, 516, 521, 528		
Sony.....	528		
Strong.....	501, 503, 507		
Sunstar.....	505		
Tandberg.....	519		
Tandy.....	503		
Tantec.....	502, 512		
TechniSat.....	509		
Teco.....	505		
Telasat.....	513		
Telefunken.....	501, 512		
Teleka.....	503, 505, 509		
Telemaster.....	504		
Telesat.....	513		
Televés.....	502		
Thomson.....	502, 519, 525, 526, 527		
Thorn.....	502, 512		
Tonna.....	502		
Triax.....	510		
Unisat.....	505		
Unitor.....	511		
Universum.....	510		
VisioSat.....	511, 515		
Vortec.....	501		
Wewa.....	502		
Winersat.....	511		
Wisi.....	502, 509, 510		
Zhnder.....	504, 507, 522		
VCR			
Daewoo.....	502, 503		
Hitachi.....	505		
JVC.....	506		
LG.....	508, 509		
Loewe.....	538		
Panasonic.....	511, 512, 513, 514, 515, 516, 517, 518, 538		
Philips.....	500, 519, 520, 521, 522, 523		
Saba.....	539		
Samsung.....	525		
Sony.....	527, 528, 529, 530, 531		
Thomson.....	533, 536, 537, 539		
Toshiba.....	534, 535		

Learnable remote control

Your TV remote control supports a learnable function which makes it possible to read out codes coming from another remote control from equipment from another brand.

This makes it possible to use only one remote control to control all your other connected peripheral equipment. For the following equipment the highlighted keys are programmable.

Note: You can put whatever function of your other device remote under one of the highlighted keys.

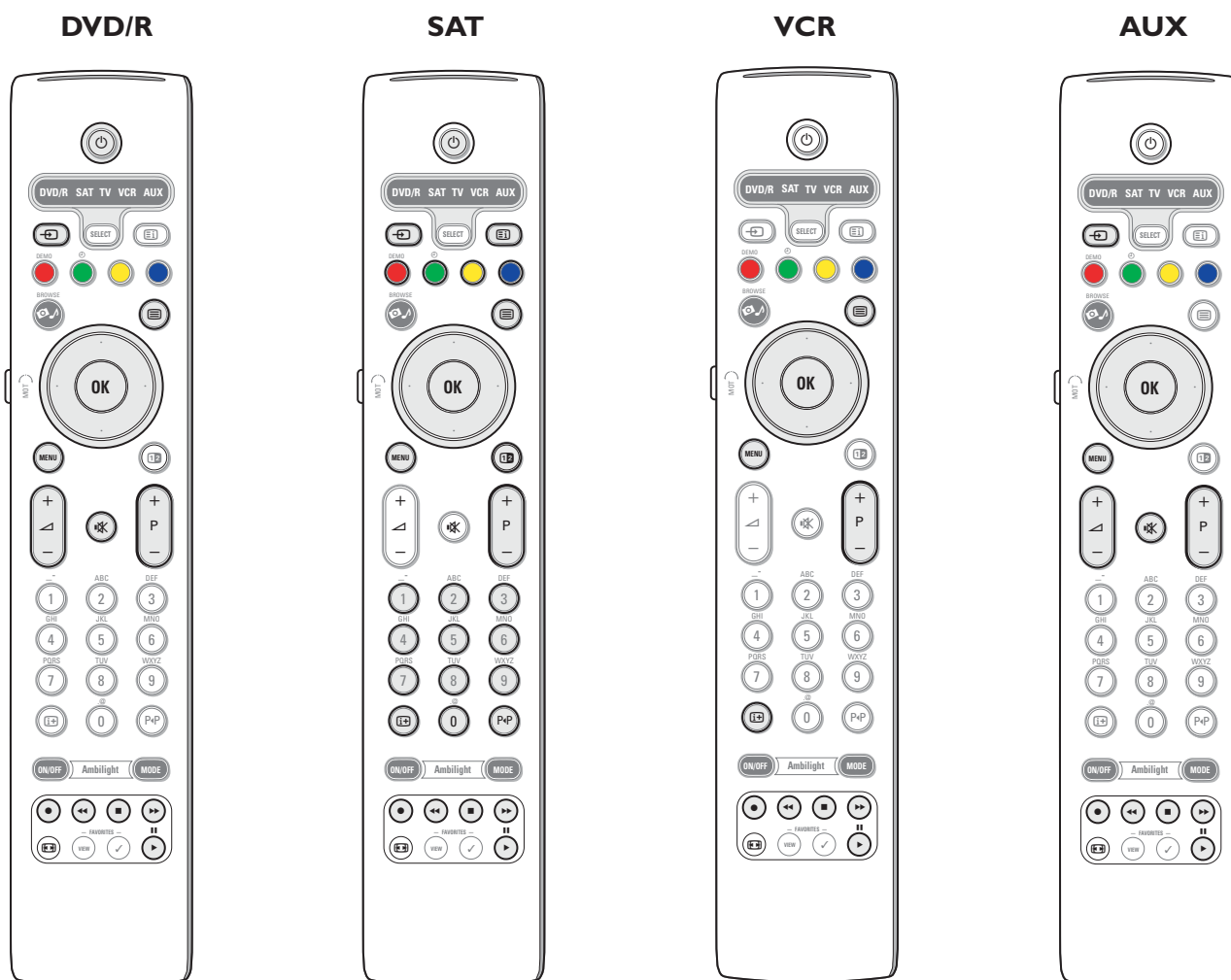

- 1 Press the **SELECT** key of your TV remote control repeatedly to select your destination source (e.g. DVD,VCR,...).
- 2 Press the **OK** key and the **⏻** key simultaneously for at least 4 seconds.
The LED of the selected source on your TV remote control will light up constantly.
- 3 Press a valid destination key on your TV remote control under which you want to copy a certain function from the remote control of the selected external equipment.
- 4 Place both remote controls face to face so that the infrared signals can be exchanged.
- 5 Press for about 2 seconds on the remote control of your external device the function key you want to be learned by your TV remote control.
The LED of the selected source on your TV remote control is blanked during the capture of the signal.
When the function is copied, the LED is lit again.
- 6 Repeat steps 3 to 5 again to copy other functions.
- 7 **To exit the learnable mode:**
Press the key at the side of your TV remote control for about 2 seconds.
Your remote control will remain the last selected mode.

Note: If a code from the remote control of your external equipment is not recognised by the TV remote control, the LED of the selected source will blink for a few seconds. This means that the code transfer did not succeed.

To put the remote control function keys back to the factory mode

- ❶ Press the **SELECT** key repeatedly to select **TV** mode.
- ❷ Press the **OK** key and the **✖** key simultaneously for at least 5 seconds.
All the **SELECT** LEDs will light up.
- ❸ Press the **SELECT** key
 - 1x: **DVD/R** is lit up
 - 2x: **SAT** is lit up
 - 3x: **VCR** is lit up
 - 4x: **AUX** is lit up
 - 5x: **DVD/R, SAT, VCR, AUX** are lit up.
- ❹ Press the **OK** key when one or all mode LEDs are lit.
The function keys which were 'learned' will be erased or from the selected destination source or from all the external equipment at once. All the keys from the TV remote control will have their factory function again.

Tips

Symptoms	Items to Check and Actions to follow
Poor Picture	<ul style="list-style-type: none"> • Have you selected the correct TV system in the manual installation menu? • Is your TV or house aerial located too close to loudspeakers, non-earthed audio equipment or neon lights, etc.? • Mountains or high buildings can cause double pictures or ghost images. Sometimes you can improve the picture quality by changing the direction of the aerial. • Is the picture or teletext unrecognisable? Check if you have entered the correct frequency. See Installation, Manual installation, p. 8.
No Picture	<ul style="list-style-type: none"> • Are the supplied cables connected properly ? (The aerial cable to the TV, the other aerial to your recorder, the power cables.) • Has the child lock been switched off ? • In case of weak or bad signal, consult your dealer. • Check if you selected the correct source.
No photo, music or video play or in poor quality only	<ul style="list-style-type: none"> • Check if the source complies with a supported code.
Digital distortion	<ul style="list-style-type: none"> • The low quality of some digital picture material may be the cause of digital image distortion. In this case select the Soft setting using the Picture menu, Smart Picture, without changing the picture settings manually. • Select Digital STB in the Source menu (p. 13) to automatically switch to the Soft setting.
No sound	<ul style="list-style-type: none"> • No sound on any channel? Check the volume isn't at minimum. • Is the sound interrupted with the mute key ?
Good sound but poor colour or no picture	<ul style="list-style-type: none"> • Adjust the contrast, colour, tint and brightness setting. Try another smart picture setting.
No solution found for your picture or sound problem ?	Switch your TV off and then on again once. Never attempt to repair a defective TV yourself. Check with your dealer or call a TV technician.
Remote control	<ul style="list-style-type: none"> • Check if the remote control is in the correct mode. • If your TV no longer responds to the remote control, the batteries may be dead. • You can still use the MENU key and the -/+ keys on top of your TV.
Standby	Your TV consumes energy in the standby mode. Energy consumption contributes to air and water pollution. Power consumption: < 1 W
No stable or not synchronised VGA picture	<ul style="list-style-type: none"> • Check if you have selected the correct VGA mode in your PC. • See HDMI connector, p. 28.
Control of peripheral equipment	The infrared signals of the screen may influence the reception sensibility of other peripherals Solution: replace the batteries of the remote control of other peripheral equipment. E.g. keep away a wireless headphone from within a radius of 1 meter.
Motorised swivel	Objects between the remote control and the remote control swivel may prevent proper operation. See p. 3.
Miscellaneous	See Extras, Specifications on this CD.

Annex 1 - Philips TV software upgrade with portable memory

Introduction

Philips offers software upgrade capability for your TV using portable memory.

After you have completed a software upgrade, your TV will typically perform better.

What improvements are made depends on the upgrade software you are using as well as the software your TV contained before the upgrade.

You can execute the software upgrade procedure yourself.

Be aware that the content of this document is addressing technical or software skilled users.

Preparing a portable memory for software upgrade

For the procedure you will require:

- A personal computer with web browsing capability.
- An archive utility that supports the ZIP-format (e.g. WinZip for Windows or Stuffit for Mac OS).
- A preferably empty USB memory stick or memory card (if available).
Supported memory cards (if available): CompactFlash Card Type I & II, IBM Microdrive, Memory Stick, SecureDigital Card / Mini SD Card, SmartMedia Card, MultiMedia Card.

Note: Only FAT/DOS-formatted portable memory is supported.

New software can be obtained from your dealer or can be downloaded from the www.philips.com/support website:

- 1 Go to www.philips.com/support using the web browser on your PC.
- 2 Follow the procedure to find the information and the software related to your TV.
- 3 Select the latest software upgrade file and download it to your PC.
- 4 Decompress the ZIP-file and copy the file "autorun.upg" to the root directory of the USB portable memory.

Note: Only use software upgrades that can be found on the www.philips.com/support web site.

Verifying the version of the TV software

Before starting the software upgrade procedure, it is advised to check what the current TV software is.

- 1 Select **Software Upgrade** in the Installation menu.
- 2 Press the cursor right.
The Software Upgrade menu moves to the left panel.
- 3 Select **Current Software Info** to observe the version and the description of the current software.

Settings	
Installation	Software upgrade
Language	Current software info
Automatic installation	Local upgrades/applications
Manual installation	
Reshuffle/rename channels	
Preferred channels	
Software upgrade	
Info	

Automatic software upgrade procedure

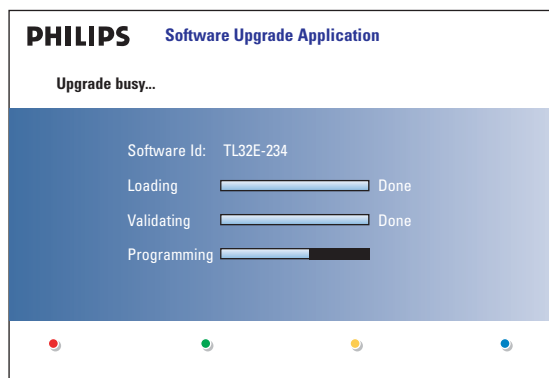

- ❶ Switch off your TV and remove all memory devices.
- ❷ Insert the USB portable memory that contains the downloaded software upgrade.
- ❸ Switch on your TV with the power key  at the top of the TV.
- ❹ At startup the TV will scan the USB portable memory until it finds the update content. The TV will automatically go to the upgrade mode. After a few seconds it will display the status of the upgrade procedure.

Warning:

- You are not allowed to remove the USB portable memory during the software upgrade procedure!
 - In case of a power drop during the upgrade procedure, don't remove the USB portable memory from the TV. The TV will continue the upgrade as soon as the power comes back.
 - If you try to upgrade to a software version lower than the current version, a confirmation will be asked. Downgrading to older software should only be done in case of real necessity.
 - If an error occurs during the upgrade you should retry the procedure or contact your dealer.
- ❺ When the software upgrade was successful, remove the USB portable memory and restart your TV with the power switch  at the top of the TV.

Your TV will start up with the new software.

Note: Once the upgrade is finished use your PC to remove the TV software from your USB portable memory.

Manual software upgrade procedure

Settings	
Installation	Software upgrade
Language	Current software info
Automatic installation	Local upgrades/applications
Manual installation	
Reshuffle/rename channels	
Preferred channels	
Software upgrade	
Info	

For a manual software upgrade copy the "autorun.upg" file in a directory called "Upgrades" located in the root of the USB portable memory.

- ❶ Insert the portable memory that contains the downloaded software upgrade.
- ❷ Select **Software Upgrade** in the Installation menu. Go to **Local upgrades/applications**. The TV will list all compatible images available on the USB portable memory and display the data for each selected upgrade image.
- ❸ Select the correct upgrade image and press the red colour key to start the upgrade. Your TV will restart and will automatically go to the upgrade mode. After a few seconds it will display the status of the upgrade procedure.

Warning:

If you try to upgrade to a software version equal or lower than the current version, a confirmation will be asked. Downgrading to older software should only be done in case of real necessity.

- ❹ When the software upgrade was successful, remove the USB portable memory and restart your TV with the power switch  at the top of the TV. Your TV will start up with the new software.



Annex 2 - Philips TV Slideshow Format with background music

Notes:

- The latest version of this document can be found on the Philips support website (www.philips.com/support). Use the type number of your TV (42PF9830/93) to find this documentation and other related files.
- Philips can't be held responsible for any problems that may occur as a result of the content in this document. Errors reported to Philips will be adapted and published on the Philips support website as soon as possible.

Introduction

This document explains how to make a Philips slideshow file with background audio. Be aware that the content of this document is addressing technical or software skilled users. To start the slideshow open the slideshow file in the Multimedia browser of your TV.

- 1 Press the  key on the remote control after having inserted a memory card or USB device and switched on the TV.
- 2 Go to where you stored the slideshow file (.alb) on your portable memory.
- 3 Select the slideshow file and press the **OK** key to start the slide show.
- 4 To stop a slide show, press the  key.

General Rules

- The slideshow will use plain ASCII XML syntax to allow the creation and editing of the slideshow files using simple tools.
- All references to network content must be based on the global address of the content.
- Content on a Portable Memory (PM) doesn't have a global address; as a result content from a PM can never be referenced from a slideshow not stored on the PM itself.
- To maintain portability, a slideshow stored on a PM should ONLY reference content on the same PM. Referencing global addresses can result in inconsistencies if the PM is used on a non-networked CE device. The latter is however not forbidden, it is only a recommendation.
- It is preferable that URL's referencing PM content are based on a relative path starting from the directory where the slideshow is stored. This path includes the device or drive name of the PM.
An absolute path to content will also be supported.
 - relative path: pictures\test1.jpg, tamper.jpg, ..\new\bird.jpg, ...
 - absolute path: USB1:\pictures1\foo_bar.jpg, C:\f1.jpg, \organization.jpg, ...

General Format

The format and syntax below will be used to create the slideshow file (simple ascii text) with the extension .alb (.ALB)
Examples: slshow1.alb, summer_holiday_2004.ALB, test.alb, ...
The following syntax should be used to create the text file:

```
<?xml version="1.0" encoding="ISO-885h9-1" ?>
<philips-slideshow version="1.0" >
  <title>Title of the slideshow</title>
  <audio>audio_url</audio>
  <slide-duration>30</slide-duration>
  <slides>
    <slide>slide_1_url</slide>
    <slide>slide_2_url</slide>
    <slide>slide_3_url</slide>
    <slide>slide_4_url</slide>
    <slide>slide_5_url</slide>
    <slide>slide_6_url</slide>
    ...
    <slide>slide_N-1_url</slide>
    <slide>slide_N_url</slide>
  </slides>
</philips-slideshow>
```

Supported XML-tags

The following table gives a description of the XML syntax.

Tag Name	Use	Description
philips-slideshow	mandatory	Philips slideshow signature including the version.
title	optional	The title of the playlist.
audio	optional	The audio-URL following this tag will define the music playing in the background during the slideshow. A single song or playlist (.m3u & .pls) are the only valid audio references. Other reference will not result in any audio playback. If a single song is referenced the song will be repeated forever. If a playlist is referenced the playlist will be played in sequence with a repeat at the end of the playlist.
slide-duration	optional	The default display time (in 0,1 second) of a slide. The TV application isn't obliged to support this tag. The TV application can force the use of one or multiple predefined display times.
slides	mandatory	Identifies the slides to show.
slide	optional	Identifies the URL of the individual slide.

Examples:

See on this CD in the directory Files/Slideshow/....

Copy the directory with the slideshow files to your portable memory.

```
<?xml version="1.0" encoding="ISO-885h9-1" ?>
<philips-slideshow version="1.0" >
  <title>Philips AlbumFile</title>
  <audio>Music\Nature.mp3</audio>
  <slide-duration>50</slide-duration>
  <slides>
    <slide>Images\Image01.jpg</slide>
    <slide>Images\Image02.jpg</slide>
    <slide>Images\Image03.jpg</slide>
    <slide>Images\Image04.jpg</slide>
    <slide>Images\Image05.jpg</slide>
    <slide>Images\Image06.jpg</slide>
    <slide>Images\Image07.jpg</slide>
    <slide>Images\Image08.jpg</slide>
    <slide>Images\Image09.jpg</slide>
    <slide>Images\Image10.jpg</slide>
    <slide>Images\Image11.jpg</slide>
    <slide>Images\Image12.jpg</slide>
  </slides>
</philips-slideshow>
```

Annex 3 - Philips TV - Portable Memory and USB

Notes:

- The latest version of this document can be found on the Philips support website (www.philips.com/support).
- The software of your TV is upgradeable. If you have problems first check if you have the latest software installed on your TV. The latest software, together with instructions, can be found on the Philips support website.
- Use the type number of your TV (42PF9830/93) to find this documentation and other related files.
- Philips can't be held responsible neither for any errors in the content of this document nor for any problems as a result of the content in this document. Errors reported to Philips will be adapted and published on the Philips support website as soon as possible.

Digital Content Issues

- Only FAT (DOS) formatted (initialized) portable memory is supported. Errors in this formatting can result in unreadable content. If such problems appear try to re-format the card. Be aware that formatting the card will also delete all the content on it (pictures, music, ...).
- The following file types are supported: .jpg, .jpeg, .mp3, .alb, .m3u and .pls.
- Only linear JPEG picture formats are supported. Progressive JPEG encodings are not supported.
- The length of a filename or directory name is limited to the length specified by the FAT12/16/32 file systems.
- Max. levels of nested directories is 19.
- Never use the supported file type extensions (.jpg, .jpeg, .mp3, .alb, .m3u and .pls) as extensions for directories as these directories will be treated as corrupted files.
- The MP3 decoder does not support MPEG1 Layer 1 or Layer 2 playback.
- MP3 Pro files can be played with normal MP3 quality.
- The access and response time of the content on a device can differ depending on the type or brand of the device.
- The access and response time of the content on a device will decrease the more unsupported or corrupted files are on the device.

Portable Memory Issues

- The following memory cards* are supported by the digital media reader:
 - CompactFlash Card (Type I & II) (CF)
 - IBM Microdrive
 - Memory Stick + Memory Stick Pro
 - SecureDigital Card (SD)
 - SmartMedia Card (SM)
 - MultiMedia Card (MMC)
- XD cards are supported through an external XD compatible card reader (not supplied with the TV) connected to the USB connector. The same holds for other future memory cards.
- Do not apply excessive force when inserting a memory card into the digital media reader. If the memory card doesn't fit or isn't detected by the TV, try to flip over the card and re-insert it.
- When inserting multiple cards at the same time some card combinations will work. It is however recommended to insert maximum one memory card at the same time.

* Trademarks and trade names belong to their respective owners.

Digital Camera Issues

If a USB connection between your digital camera and the TV isn't working, you can try the solutions below to resolve your problem.

- Make sure your digital camera is switched on and verify if the configuration of your digital camera is correct (see the manual of your digital camera for more information).
- Some digital cameras allow you to switch off the USB interface. Make sure that the USB interface is switched on before connecting to the TV.
- Remove the memory card from your digital camera and insert it directly into the digital media reader on the right side of your TV.
- If you have a digital camera with only internal memory (no removable memory) you can try to copy the content manually to a memory card or a USB memory device (e.g. Philips KEY product) using a personal computer.
- Some digital cameras allow you to switch between PTP (Picture Transfer Protocol) or "PC Link" and USB Mass Storage or "PC Drive". Make sure that you select USB Mass Storage or "PC Drive" on your digital camera.
- If your camera supports different interface settings be sure to try them one by one or contact the reseller of your camera to find out the correct setting.

USB Memory Device Issues

- Devices connected to the USB port of your TV must be “Mass Storage Class” compliant. If your device (digital camera, MP3 player, portable harddisk, ...) is not “Mass Storage Class” compliant it will not be detected by the content browser of the TV.
- The following subsets of the Mass Storage Class specification are supported:
 - The implementation of the TV is based on the “Universal Serial Bus Mass Storage Class Specification Overview” (v1.2, June 23, 2003) including all documents referenced by the document. The document can be found on the USB standardisation website (www.usb.org).
 - Full support of the USB Mass Storage Class Bulk-Only Transport (bInterfaceProtocol = 50h).
 - Full support of SubClass Code = 05h; SFF-8070i spec.
 - Full support of SubClass Code = 06h; SCSI transparent command set.
- For large USB memory devices, when you are in the Content Browser, it may take a long time before you can access your files.
- When using a USB portable harddisk: Due to the high power consumption of the harddisk, it is advised to use the external power supply of the portable harddisk to guarantee proper working under all conditions.